

## Table of Contents

**Section 1**  
**CTI by ZOT**  
 82-70 Pages 2-8  
 82-90 Page 9  
 82-30 Pages 10-11

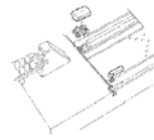

**Section 4**  
**Foul Detectors**  
 Pages 20-25

**Section 2**  
**Glow Bowling Products**  
 Pages 12-15

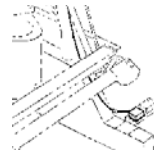
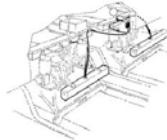

**Section 5**  
**Electronic Triggering**  
 Pages 25-27

**Section 3**  
**Unique Parts**  
 Pages 15-19

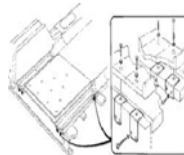
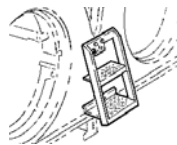

**Section 6**  
**Lane Products**  
 Pages 28-29

See Back Cover for Ball Conditioner Products

**IMPORTANT NOTICE**

**Call your ZOT Distributor or ZOT Pinsetter Parts, Inc. for Pricing**  
**Tel: 1-800-525-8116 Toll-free 1-800-525-8116**

### Back End Controller

For AMF 82-70 MP Chassis, 5-Board and Converted Chassis



**#400253 (2-lane unit)**

**Prevents Pin Waterfall Effect:** The ZOT Unit will turn off the back-end motor (distributor): when a pin-jam occurs in any position of the shuttle.

**Mechanics Alert Indicator:** A LED signals when the ZOT unit stops the distributor and back-end motor. The back-end motor will be turned off when (1) a pin jam occurs (e.g., when more than one pin is placed in any position on the shuttle), (2) when the Pinspotter has been idle for more than a preset number of minutes.

**Prevents Damage:** The ZOT product reduces damage to Pinspotter parts (e.g., distributor drive shaft parts) and to pins: by switching off the back-end motor.

**Saves Wear & Tear and Reduces Power Consumption:** An adjustable Time-Out can be set on a DIP Switch to stop the back-end motor: in a range of 3 to 6 minutes.

**Self Restart:** When the back-end motor has timed out (turned off) it will turn back on automatically immediately when a ball contacts the pit cushion.

**Manual Restart:** When the back-end motor has been turned off by a pin-jam, the distributor will turn on automatically when the pins have been cleared from the shuttle.

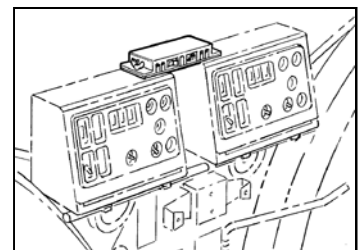
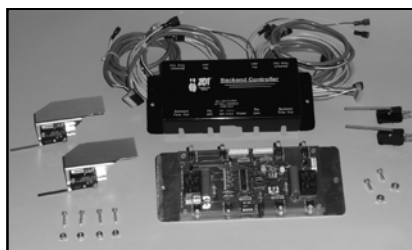

# Mask Light Bulb Replacement

"Replace incandescent bulbs with LED's"

**#400265 Red LED (12-Volts)** for centers with AMF Pinspotters

**#400261 Red LED (24-Volts)** for centers with Brunswick Pinsetters

ZOT has made improvements to the LED replacements for incandescent light bulbs on Mask units. The new LED's are RED (when lit), which yields a "greater degree of brightness" in typical bowling center lighting.

**The Effective Life** of the product is 100 times longer than the bulbs they replace. That's a life expectancy of 100,000 hours of run time.

**Power Saving:** LED's use less than 1/10th of the power used with incandescent bulbs.

**They are easy to install:** Simply push and turn, just like the old bulb.

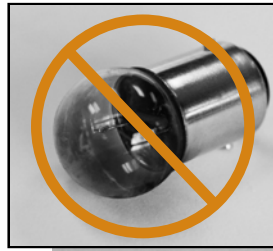

**"Improved"**  
Increased Brightness  
Level



# Mask Light Conversion Kit

**#400262**



- **Stop Constant Replacement:** of older technology incandescent lamps. #90, #94, #624, #1692 and #68 lamps are rated to last 750 hours. LED Technology will run for 100-thousand hours — that's a life expectancy that's more than 100-times longer
- **Discard Aging and Worn Sockets:** remove problem sockets, obsolete worn contacts and aging wires.
- **Simple Mounting:** easy drill & screw LED & Lens system to the front of the mask unit.
- **Saves Power:** The LED Light uses less than 1/10th of the power (current) than the old #90 incandescent lamp.
- **Optional Wire Replacement:** easy screw /wire connection at the LED PC Board enables you to connect with a 6" jump-wire, or you can replace the complete run using your own wire.

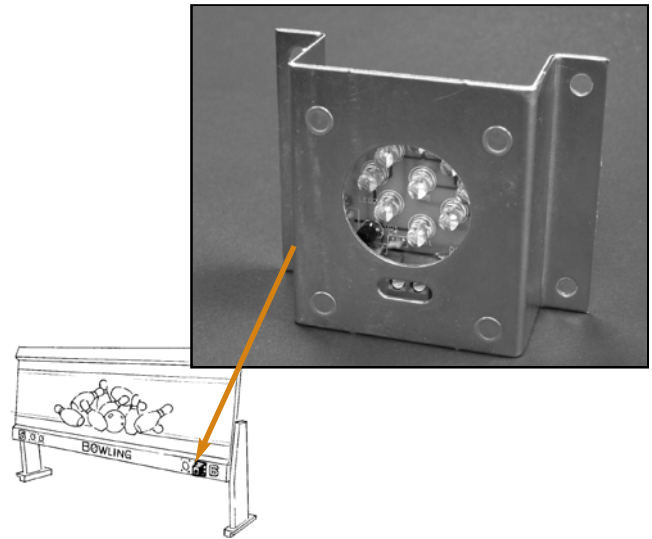

# NEW Replacement Parts for CTI/ZOT Ultra Chassis

For all 2-Board Chassis

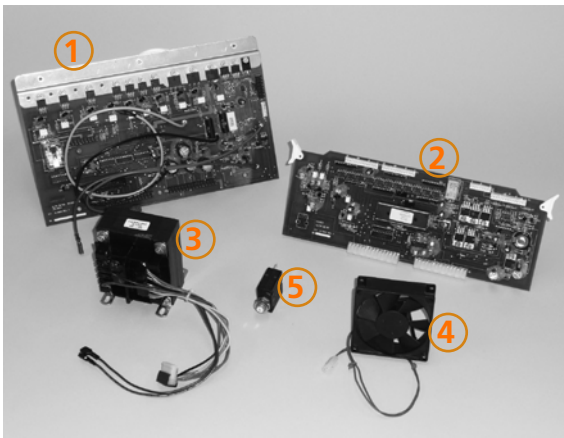

- ① Driver Board #431070
- ② MPU Board #431069
- ③ Transformer 115v #400231
- ④ Fan Assembly #400249
- ⑤ Resettable Breakers  
 #220040 12-AMP  
 #220039 10-AMP  
 #220016 2-AMP  
 #220038 1-AMP

**Replacement Fuses for Ultra 98 & Ultra 98 Plus**  
 #220022 15-AMP  
 #220023 1.5-AMP  
 #220009 10-AMP